



INSTALLATION DATA MANUAL

Model 510 Pressure Transmitter

199 Fire Tower Drive
Tonawanda, NY 14150
Toll Free: 1-800-688-0030
International: 1-716-629-3800
Fax: 716-693-9162
www.viatran.com
solutions@viatran.com

PRODUCT OVERVIEW

NOTE: All information contained in this document is representative of a standard Model 510. If the product you ordered has special requirements or modifications, refer to the Laser Marked information on the product and your purchase order for possible alteration to the product's configuration. Failure to verify product configuration before installation may cause permanent product damage, and in most cases, void the manufacturer's product warranty. If you are unsure or have questions about your product, please contact our Application Engineers for assistance. Remove and retain all instruction manuals and performance certificates that are shipped with the product. These documents provide important information on the product's calibration, operation, safety precautions, recommended maintenance, re-calibration requirements, repair service instructions and warranty information. These documents are updated from time to time as changes to the product occur and should be reviewed at receipt so that proper and safe installation can occur.

DESCRIPTION

The Viatran Model 510 is a pressure transmitter designed specifically for oil field service applications. This transmitter provides a 4-20 mA signal output proportional to pressure. The Hammer Union pressure connection and low-profile design make it ideal for use at the well site. The field calibration feature makes the Viatran 510 Series a leader in oil field pressure instrumentation.

GENERAL REQUIREMENTS & CAUTIONS

Note: This is only a partial list. Please refer to the Installation Data section of this manual for specific requirements.

1. All electrical & pressure connections should be compatible with the model specifications as outlined in the Installation Data section of this manual.
2. Installation should occur only after electrical (input power) and line pressure is verified as being off and at zero.
3. The product's internal electrical circuitry is isolated from case ground. It is not recommended that the case or ground of the unit be connected to the input, output or calibrate pins of the product or wiring system. Ground loops and line noise will affect the product's performance and will in most cases cause internal electrical failure.
4. All products should be protected from direct or continued exposure to fluids at the electrical connection. It is recommended that for products installed in areas where the potential for contamination at the electrical connection is possible, protective measures be taken to eliminate possible deterioration of the product's electrical connection and corrosion that will impede product performance.
5. At no time should an object be inserted into the pressure port or pressed against the sensing area to deflect the sensor (to test or simulate pressure), as on some models, permanent damage to the sensing diaphragm may occur.
6. Never - Remove the transmitter when it is under pressure, if it is hot, or if it exposes noxious gases.

HANDLING

Although there are variations within the series of sensors, the nominal weight of the assembly is about 5.5 lbs. This is of significant size and a handle is available to facilitate handling. High surface temperatures can remain in place and the unit should be checked before removing the unit from service if it was operated at high temperatures. Suitable gloves are recommended for handling the unit under those conditions. There are no sharp edges associated with the instrument.

INSTALLATION REQUIREMENTS & CAUTIONS

1. To comply with CE requirements for electromagnetic compatibility, the transmitter case must be earthed by the ground lug at the connector.
2. It is recommended that the connector cover be placed on the product's connector after each use. Simple cleaning and removal of foreign material in the connector will increase the life and operation of the product.
3. The carrying handle and connector cover should be used when the product is being handled or transported between locations.
4. Installation of the unit is accomplished by placing the pressure transmitter into the Hammer Union pressure fitting and securing the unit by tightening the Hammer Union Nut (Fig. 1) over both the unit and pressure fitting. Once installed, check for leaks and adjust as necessary.



5. When installing the unit to the pressure connection, care should be taken to avoid direct hits to the unit. A direct hit from a sledgehammer to the product itself could cause latent failure to the product. Direct hits can result in the loss of retention clips, failure of the electrical connector or electronics, or bending of the top assembly from the body which would allow sensor cavity contamination. In all cases this would be determined as a non-warranty related product failure and repair.
6. Product fasteners must be replaced when found to be missing or broken. Spare fastener kits are available from Viatran to maintain the seal of the product. If the product is operated with missing or broken clips, the potential for seal failure is considerable. In all cases this would be determined as a non-warranty related product failure and repair.

Adapter & Connector Bolt Torque Settings

*

Connector Fasteners:

- Size 4-40 (with gasket) = 4 in-lbs
- Size 4-40 (no gasket) = 8 in-lbs
- Size 6-32 = 25 in-lbs

Adapter Fasteners:

- Size 8-32 = 40 in-lbs

Installation Data – Viatran

Model 510 Wiring:

- Pin A: +Signal/Power
- Pin B: - Signal/Power
- Pin C: No Connection
- Pin D: No Connection
- Pin E: +Calibration
- Pin F: - Calibration
- Gnd Lug: Case Ground

* Lightly hand-tighten bolts in alternating fashion (star pattern).

Ensure that the item to be secured is fully and evenly seated, and the O-ring, if applicable, is fully compressed. Torque bolts in alternating fashion (star pattern).

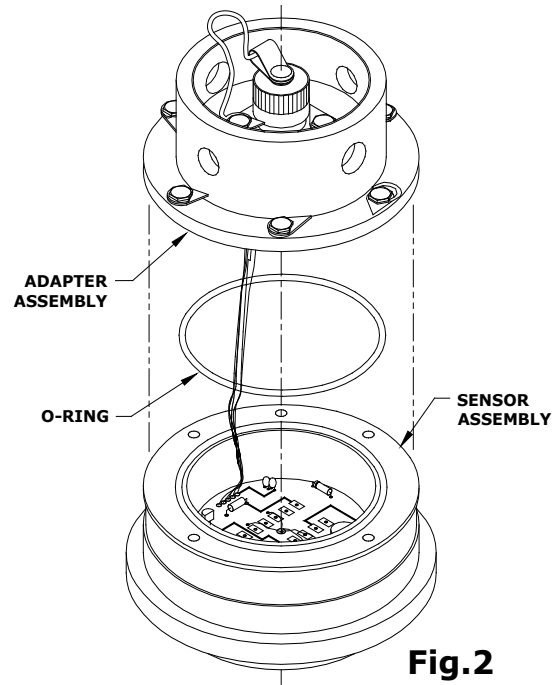

Fig.2

To activate cal on Model 510, the cal circuit must be powered.

- Input:** 10.5 – 28 VDC
- Output:** 4 to 20 mA
- Cal Input:** 7.0 to 28 VDC

Sensor Construction:

All Ranges: Inconel 718 or Inconel X-750

Electrical Connector:

6 pin bayonet (standard)

Pressure Connection By Range:

5,000, 6,000, 10,000, 15,000 & 20,000 PSI: 1502 Hammer Union

Connection Diagrams

(Non-Hazardous environments)

For Hazardous locations, see attached connection Diagram per approval code ordered.

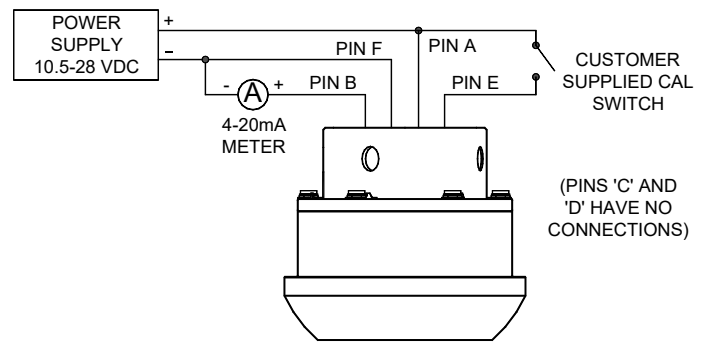

MODEL 510



TONAWANDA, NY 14150
www.viatran.com
716-629-3800

+ STANDARD VIATRAN PRODUCT MARKING

P/N: 510XXX

S/N: 123456

Press. Range: 123456 PSIS

Proof Press: 123456 PSIS

Input: 10.5-28VDC

Output: 4-20mA

Mfg. Year: xxxxx

C/O: xxxxx

CONNECTIONS:

Pin A: +Sig/Pwr Pin D: N/C

Pin B: - Sig/Pwr Pin E: +Calibrate

Pin C: N/C Pin F: - Calibrate

FIELD CALIBRATION

The 510 Transmitter is provided with a unique feature which permits field calibration to be performed by electronically simulating pressure. Powering the calibration terminals produces a signal output equivalent to approximately 100% of full scale pressure. The factory set calibration signal is located on the calibration certificate that is shipped with each unit. This can be used to adjust the gain on the user's meter or data acquisition equipment. The cal signal is also an indication that the unit is working properly. Zero and span adjust are also featured on the Model 510 and should not be confused with cal activation. Model 510 is available with an optional digital trim kit which may be purchased separately from the factory by ordering part number 005500.001.

ADAPTER REPLACEMENT INSTRUCTIONS

Using Ring Pliers, (Waldes Truarc, No. 0200, Rotorclip, RP-200 or equiv. recommended) with stop set to 1/4 inch, remove the retaining rings from the 6 fasteners holding the adapter to the sensor. Dispose of the used retaining rings, remove and dispose of the teardrops, remove the bolts using 1/4" socket and dispose of them. Carefully remove the adapter assembly from the sensor & place upside-down next to sensor. The adapter will still be connected to sensor by 4 wires, do not put excessive strain on these wires or the Micro-fit connector on PC Board attached to the adapter. Unplug the Micro-fit connector on the PC board (needle nose pliers recommended). Remove the 'O'-Ring from the sensor & dispose of; Set the sensor aside.

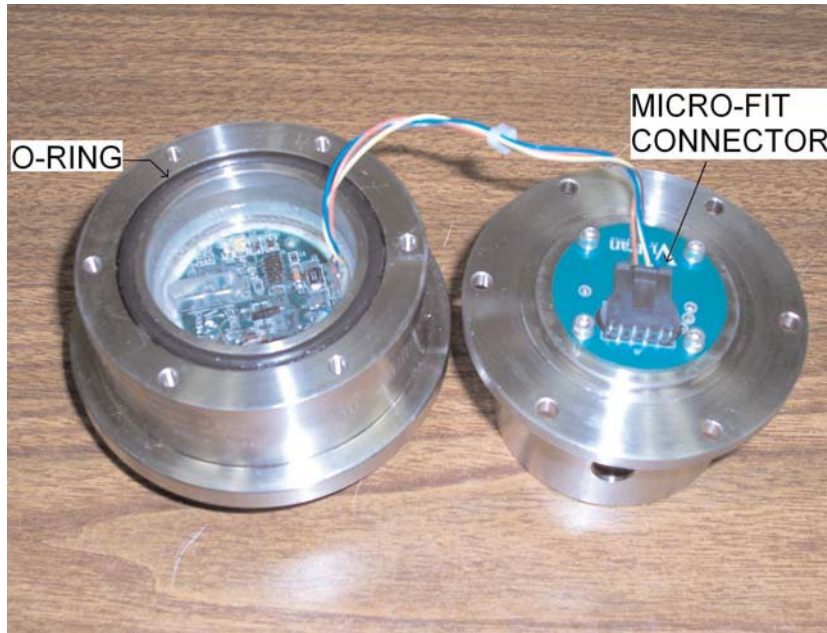





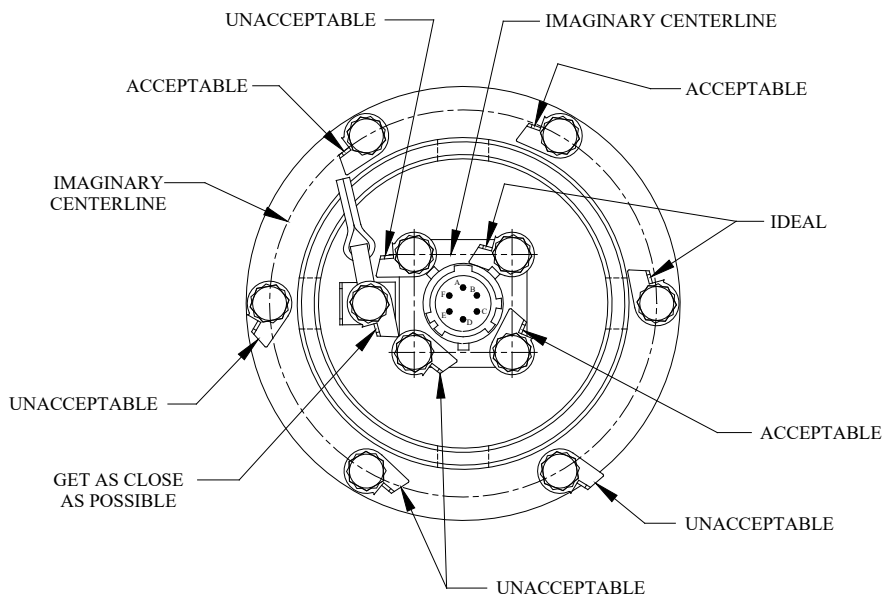







From the replacement kit remove the replacement sensor 'O'-Ring & package of grease. Grease the 'O'-Ring and place it in the groove. Attach the Micro-fit connector to PC board on the new adapter.

Place the new adapter on the sensor & attach it with the (6) [8-32] bolts from the replacement kit. Lightly hand-tighten bolts in alternating fashion (star pattern). Ensure that the adapter is fully and evenly seated and the O-ring is fully compressed. Then torque the bolts to 40 in.-lbs. in alternating fashion (star pattern). From the replacement kit remove the replacement (6) teardrops & (6) retaining rings. Place the teardrops over the bolt heads as shown in the picture to stop the fastener from loosening. Using Ring Pliers, install the retaining rings.



OPTIONAL CERTIFICATIONS

1. Enclosure Classification: NEMA 4X (Standard)
2. Hazardous Locations Classifications/Marking: (Approval option codes specified in part number to obtain appropriate agency labeling.) See the product & connection drawing for any approvals & ratings for your unit, if applicable. The following are typical examples

<p>510_NX_</p>  <p>CSA 03.1437390</p> <p>INT. SAFE FOR CL I, DIV 1, GP A,B,C,D CL I, ZN 0, Ex ia IIC INSTALL PER CD0666 T4, Ta=80°C, T5, Ta=40°C HAZ. LOC.</p>	<p>510_TF_</p>  <p>APPROVED</p> <p>INT. SAFE FOR CL I, DIV 1, GP A,B,C,D CL I, ZN 0, AEx ia IIC INSTALL PER CD0666 T4, Ta=80°C, T5, Ta=40°C HAZ. LOC.</p>	<p>510_NK_</p>  <p>II 1 G</p> <p>Ex ia IIC Ga Presafe 16 ATEX 8465X T4: -20°C < Ta < 80°C T5: -20°C < Ta < 40°C Ui=28V, Ii=100mA, Pi≤1W Ci=2.2nF, Li=0.5mH</p>  <p>2460</p>	<p>510_TW_</p>    <p>TC RU C-US.BH02.B.00653/18 0Ex ia IIC Ga T4: -20°C < Ta < 80°C T5: -20°C < Ta < 40°C METROLOGY CERT: OC.C.30C001.A No 73774</p>	<p>510_TG_ or 510_NXTF_</p>   <p>CSA 03.1437390 APPROVED</p> <p>INT. SAFE FOR CL I, DIV 1, GP A,B,C,D T4, Ta=80°C, T5, Ta=40°C Canada: CL I, ZN 0, Ex ia IIC USA: CL I, ZN 0, AEx ia IIC INSTALL PER CD0666 HAZ. LOC.</p>	<p>510_KP_</p>  <p>II 1 G</p> <p>Ex ia IIC Ga DNV 22UKEX23854X T4: -20°C < Ta < 80°C T5: -20°C < Ta < 40°C Ui=28V, Ii=100mA, Pi≤1W Ci=2.2nF, Li=0.5mH</p>   <p>8501</p>  <p>2460</p>
---	--	---	--	---	--

SPECIAL CONDITIONS FOR USE

Certificate	Type	Special Instruction
Presafe 16 ATEX 8465X	ATEX IS	<ol style="list-style-type: none"> 1. The flying leads must be protected by an enclosure of at least IP 20 when mounted. 2. For units provided with a non-metallic dust cap, care shall be taken to avoid electrostatic charging of the dust cap. Do not rub or clean with solvents. Use only a water damp cloth.
DNV 22 UKEX 23854X	UKEx IS	<ol style="list-style-type: none"> 1. The flying leads must be protected by an enclosure of at least IP 20 when mounted. 2. For units provided with a non-metallic dust cap, care shall be taken to avoid electrostatic charging of the dust cap. Do not rub or clean with solvents. Use only a water damp cloth.

INTENDED USE AND MISUSE

The standard configuration of this instrument is designed for use with materials compatible with Inconel 718 and X-750. If fluids that are not compatible are used, accelerated corrosion rates are likely to be seen. This will result in premature failure of the diaphragm.

MAINTENANCE AND REPAIR

All Viatran transmitters have been designed to function free from routine or scheduled maintenance. Simple cleaning of the electrical connector, pressure port threads and pressure cavity on an as needed basis will provide many years of satisfactory performance. Protecting the product from continued exposure to moisture or fluids at the electrical connection will eliminate premature internal failure of the product. Generally, any time the product is removed from service the connector and pressure port should be cleaned and the pressure cavity flushed with an Inconel 718 & X-750 compatible cleaner to prevent media buildup. During the cleaning process only a soft, lint-free cloth is recommended. Never use a coarse or stiff bristle brush to clean media from the diaphragm surface.

It is suggested that the calibration be verified on a usage dependent schedule. If the product is in continuous service 7 days a week, then calibration verification may be necessary every 6 to 8 months. If the product is in a lab test environment a more lenient verification schedule would be appropriate. In all instances the performance of the product will depend on the individual application or process in which it is installed. More continued usage would require a shorter period between calibration verification and product maintenance.

If a product is perceived to be exhibiting problems, it can be returned to Viatran for analysis and/or repair. It is suggested that

only Viatran personnel attempt repair of the product. Any damage resulting from customer disassembly would result in a loss of coverage under the warranty policy. All Viatran products are able to be repaired at minimal cost if simple cleaning and precautions are taken in the handling and application of the product. Older products returned for repair are updated to current specifications unless the repair cost would outweigh the cost of a new replacement model. Products returned for repair should include information on the person to contact for repair quote approval, the individual to contact if Viatran's technical staff requires additional information during analysis, and a brief description of the problem associated with the product's failure.

WARRANTY

Viatran Corporation products shall be free from defective workmanship and/or material for a period of twelve (12) months from date of shipment, provided that Viatran's obligation hereunder shall be limited to correcting any defective workmanship and/or replacing any defective material F.O.B. destination. If inspection by the Company of such product does not disclose any defect of workmanship or material, the Company's regular charges will apply. The warranty carries no liability, either expressed or implied, beyond our obligation to replace the unit which carries the warranty. This warranty is in lieu of all other warranties of merchantability or fitness. No allowance will be made for any expense incurred for correcting any defective workmanship and/or material without written consent by Viatran. Unit must be shipped to the Company, transportation prepaid, and return tracking number must be referenced on the package to assure acceptance at our shipping dock. Prices, specifications and decisions are subject to change without notice.

This warranty is void if the product is subjected to misuse, accident, neglect improper application, installation or operation. This warranty is void if prior defects in materials or workmanship repairs are made by anyone except Viatran or its authorized service agency.

REPAIR

If failure occurs, the sensor should be returned to the factory for inspection and testing. If the failure is covered by our warranty policy as stated above, the unit will be repaired as necessary and reshipped without delay. Sensors usually not covered by warranty can be repaired within two to three weeks (after approval) for approximately 20-60% of the purchase price. Simple repairs can often be made for a minimal charge. A repair is warranted ninety (90) days from repair date under conditions of original warranty period unless superseded by original warranty period. To return a unit, please contact the Customer Support Department for a Return Tracking Number at 1-800-688-0030.

199 Fire Tower Drive
Tonawanda, NY 14150
Toll Free: 1-800-688-0030
International: 1-716-629-3800
Fax: 716-693-9162
www.viatran.com
solutions@viatran.com