














## MDA / LDA / TDA Series

Pressure transducers for high temperatures and high pressures

# Operating Manual



# Table of Contents

Content	Chapter	Page	Icon
General	1	3	
Notes on safety	2	5	
Technical data	3	6	
Function	4	13	
Transport/delivery	5	14	
Installation	6	16	
Commissioning	7	24	
Maintenance	8	26	
Accessories	9	28	
Troubleshooting	10	29	
CE- Declaration of conformity	11	30	



## 1. General



- 1.1 Important information
- 1.2 Copyright
- 1.3 Explanation of icons
- 1.4 Abbreviations
- 1.5 Correct use
- 1.6 User's obligations

### 1.1 Important information

This manual applies to the MDT 420/460/435/467 and PT 420/460, TDA 432/463 and LDA 415 series only. It must be kept near the equipment in a readily and immediately accessible location at all times.

The content of this manual must be read, understood and followed in all points by all relevant people. This applies in particular to the notes on safety. Following the safety instructions will help to prevent accidents, defects and malfunctions.

**DYNISCO** will not be held liable for any injury, loss or damage resulting from failure to follow the instructions in this manual.

If malfunctions occur in spite of having followed the operating instructions, please contact the **DYNISCO** customer service department (see chapter 8, Maintenance).

This applies in particular during the warranty period.



## 1.2 Copyright



Copyright law requires that this manual be used for inhouse purposes only.

All reproduction, even partially and for in-house purposes, requires the approval of **DYNISCO**. This manual may not be forwarded to third parties.

## 1.3 Explanation of icons

The manual uses icons to indicate information pertaining to safety:

**ATTENTION** Risk of destruction or damage to equipment, machines or installations



General danger to life or limb



Specific danger to life or limb



You **MUST** do this

The safety instructions are provided again in the individual chapters of the manual.

## 1.4 Abbreviations

The following abbreviations are used:

<b>OM</b>	Operating manual
<b>PT</b>	pressure transmitter
<b>f.s.</b>	of full scale



## 1.5 Correct use



The purpose of the pressure transducer is to measure pressure in plastic melt as part of a larger overall system. The PT can be used in media temperatures up to 400°C.

If the PT is used in other applications, the safety and accident prevention regulations specific to that application must be followed.

**When using the PT as a safety component in accordance with the EC Machine Directive, Annex IIc, the equipment manufacturer must take any necessary precautions to ensure that malfunctions of the PT cannot cause damage or injury.**

## 1.6 User's obligations

The operator or owner of the larger overall system, e.g. a machine, is responsible for following the safety and accident prevention regulations that apply to the specific application.

## 2. Notes on safety



The operator or owner of the larger overall system is responsible for following the safety and accident prevention regulations that apply to the specific application.



### **Toxic hazard!**

The PT contains a small amount (7 mm<sup>3</sup>) of mercury (Hg) as its transmission medium. If the diaphragm is damaged, mercury may escape.

Never transport or store the PT without the protective shell bolted in place. Remove the shell shortly before installation.

**If mercury is inhaled or swallowed, seek medical attention immediately!**

Mercury is hazardous waste and must be disposed of in accordance with applicable laws. DYNISCO will accept defective PTs. If mercury escapes, use airtight packaging!



When planning machinery and using the PT, follow the safety and accident prevention regulations that apply to your application, e.g.:



- EN 60204, Electrical equipment in machines.
- EN 292, Machine safety, general design guidelines.
- DIN 57 100 Part 410, Protection against electric shock.



Mounting and electrical connection of the PT must be done by specialists with EMC training, following all applicable regulations, and in pressureless, voltage-free condition with the machine switched off.

**The machine must be secured against being switched back on!**



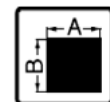
**Burn hazard!**

The PT must be removed with the melt in molten condition. The PT can be very hot when removed.



**Wear protective gloves!**

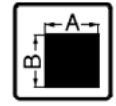
### 3. Technical Data



- 3.1 Ordering guide
- 3.2 Ordering example
- 3.3 Performance characteristics
  - 3.3.1 Accuracy
  - 3.3.2 Repeatability
  - 3.3.3 Resolution
- 3.4 Mechanical configurations
- 3.5 Pressure side connection

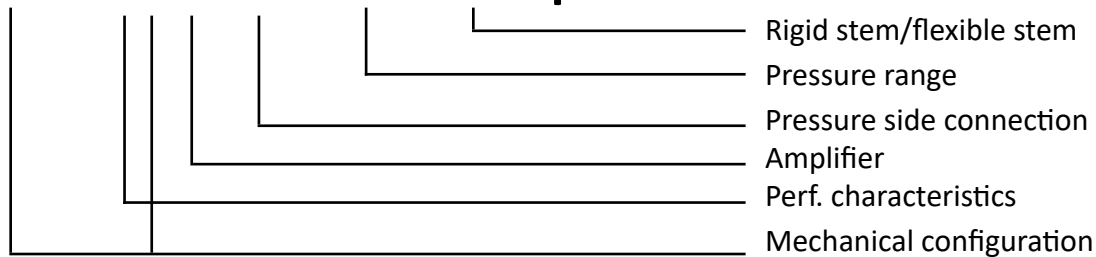


- 3.6 Pressure ranges
  - 3.6.1 Pressure ranges in bar
  - 3.6.2 Max. Overload
  - 3.6.3 Burst pressure
  - 3.6.4 Limit frequency
- 3.7 Rigid stem/flexible stem
- 3.8 Electrical Data
- 3.9 Temperature influence
- 3.10 EMC requirements
- 3.11 Materials
- 3.12 Mounting torque
- 3.13 Environmental Protection
- 3.14 Weight
- 3.15 Dimensions



### 3.1 Ordering guide

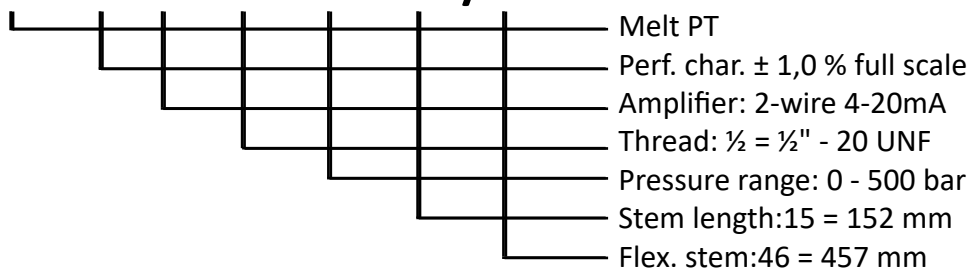
#### xDT4xx x- xx - xxx - x - Option



The exact meanings of the letter/digit combinations are given in the corresponding sections of chapter 3.

### 3.2 Ordering example

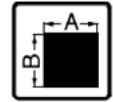
#### MDT462 F - ½ - 5C - 15/46



P/N: n/a | Rev: 1117 | ECO: n/a



### 3.3 Performance characteristics (xDT4Xx x-xx-xxx-xx)



#### 3.3.1 Accuracy

(Linearity and hysteresis at T = constant)	
xDT42x x	± 0,5 % of full scale
(35 bar and 50 bar	± 1 % of full scale)
xDT46x x	± 1 % of full scale

#### 3.3.2 Repeatability

xDT42x x	± 0,1 % of full scale
(35 bar and 50 bar	± 0,2 % of full scale)
xDT46x x	± 0,2 % of full scale

#### 3.3.3 Resolution infinite

### 3.4 Mechanical configurations (XDT4xX x-xx-xxx-xx)

<b>MDT4x0, LDA 415</b>	stem version
<b>MDT4x2</b>	rigid stem and flexible stem
<b>TDT432/463</b>	combined pressure and temperature measurement
<b>MDT435/467</b>	transducer for limited installation space

### 3.5 Pressure side connection (xDT4xx x-XX-xxx-xx)

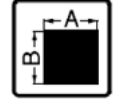
½ = ½" 20 UNF 2A  
M18 = M18 x 1,5

### 3.6 Pressure ranges (xDT4xx x-xx-XXX-xx)





### 3.6.1 Pressure ranges in bar



Model number	Permitted pressure range in bar
xDT4xx x-xx-17-xx	0 - 17 series 42x/43x x only
xDT4xx x-xx-35-xx	0 - 35 series 42x/43x x only
xDT4xx x-xx-50-xx	0 - 50 series 42x/43x x only
xDT4xx x-xx-1C-xx	0 - 100
xDT4xx x-xx-2C-xx	0 - 200
xDT4xx x-xx-3,5C-xx	0 - 350
xDT4xx x-xx-5C-xx	0 - 500
xDT4xx x-xx-7C-xx	0 - 700
xDT4xx x-xx-1M-xx	0 - 1000
xDT4xx x-xx-1,4M-xx	0 - 1400
xDT4xx x-xx-2M-xx	0 - 2000
Other pressure ranges on request	

### 3.6.2 Max. Overload (without influencing operating data)

2 x full scale pressure up to 700 bar (for 1000 bar and 1400 bar range: max. 1750 bar, and 2450 bar for the 2000 bar range)

**3.6.3 Burst pressure**                      6 x nominal value,  
max. 3000 bar

**3.6.4 Limit frequency**                      50 Hz [-3db]

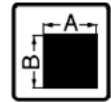
### 3.7 Rigid stem/flexible stem (xDT4xx x-xx-xxx-XX)

15 = 152 mm standard length for rigid version  
15/46 = 152 mm stem length / 457 mm flexible stem

Other lengths on request



### 3.8 Electrical data (xDT4xx X-xx-xxx-xx)



Configuration	4-arm Wheatstone bridge strain gauge with int. amplifier
Output signal	3,33 mV/V $\pm$ 2 %
Supply voltage	10 VDC (recommended) min.6 VDC, max.12 VDC
Calibration function (room temperature)	80 % $\pm$ 0,5 % of full scale output by externally connecting contacts E and F
Leakage resistance	> 1000 M $\Omega$ at 50 V

### 3.9 Temperature influence

#### Housing

Max. housing temperature	$\pm$ 120 °C
Zero shift due to temperature change on the housing	
xDA420 series	$\pm$ 0,2% full scale /10°C typ.
xDA460 series	$\pm$ 1,0% full scale /10°C typ.
Sensitivity shift due to temperature change on the housing	
xDA420 series	< 0,1 % f. s. / 10 °C typ.
(35 and 50 bar	< 0,2 % f. s. / 10 °C) typ.
xDA460 series	< 0,4 % f. s. / 10 °C typ.

#### Diaphragm (in contact with media)

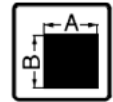
Maximum temperature at the diaphragm	400 °C
Zero shift due to temperature change on the diaphragm	
xDT 420 series	<0,2 bar / 10 °C typ.
xDT 460 series	< 0,4 bar / 10 °C typ.



### 3.10 EMC requirements

Conforming to **CE** in accordance with EMC directive.

Emitted interference	DIN EN 50081-1 (residential area)
Immunity	DIN EN 50082-2 (industrial area)



### 3.11 Materials

Diaphragm	15-5PH Mat.No. 1.4545 Armology coated
Stem	15-5PH Mat.No. 1.4545

**3.12 Mounting torque** max. 50 Nm (500 inch-lbs.)  
min. 12 Nm (100 inch-lbs.)

### 3.13 Environmental protection to IEC 529

PT housing	IP54 (without connector)
Standard connector	
PT06A-10-6S(SR)	IP40
Connector PT06W-10-6S	IP64

**3.14 Weight** 0,6 kg

### 3.15 Dimensions

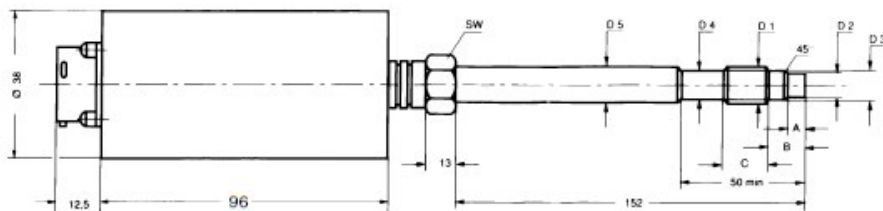


Fig. 01: MDT 420 x460 x  
with fixed stem

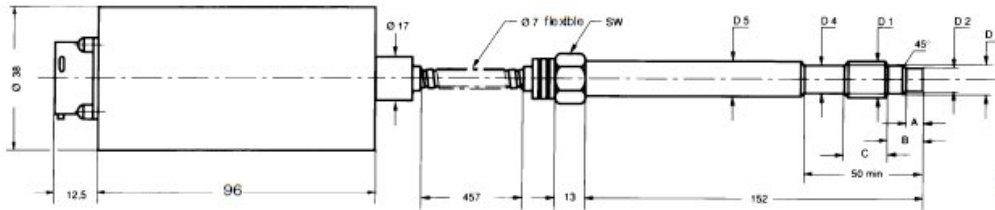
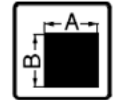


Fig. 02: MDT 422 x462 x with flexible stem

D1	D2	D3	D4	D5	A	B	C	SW
1/2"-20UNF-2A M18 x 1,5	7,8 <sup>+0,05</sup> 10 <sup>-0,05</sup>	10,5 <sup>+0,05</sup> 16 <sup>-0,1</sup>	11 <sup>-0,5</sup> 16 <sup>-0,5</sup>	12,5 18	5,3 <sup>+0,25</sup> 6 <sup>-0,25</sup>	11 14	16 20	16 19

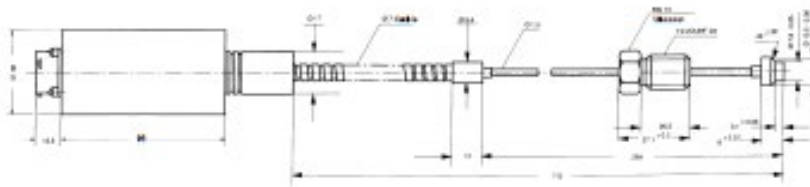


Fig. 03: MDT 426 x462 x with split tip

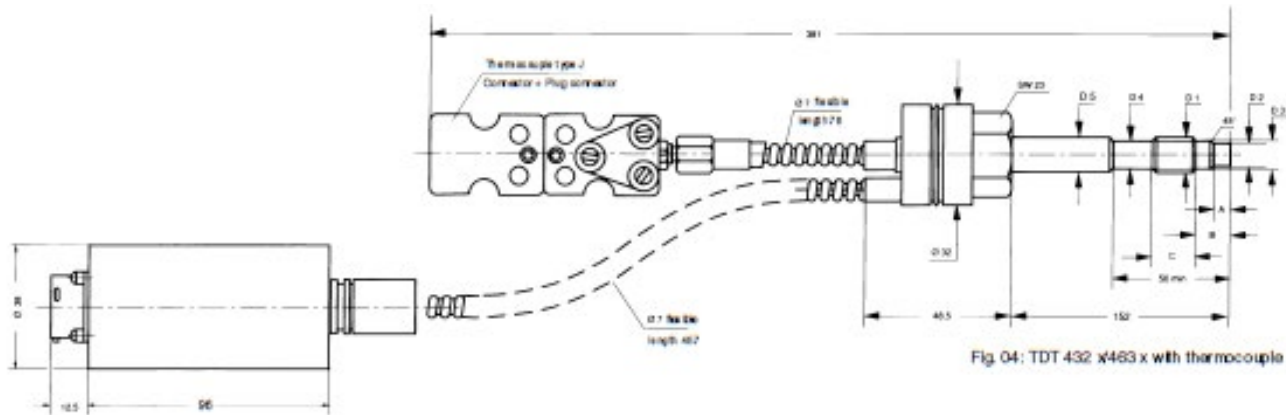


Fig. 04: TDT 432 x463 x with thermocouple



## 4. Function

### 4.1 Construction

### 4.2 Description of functions

### 4.3 PT series



## 4.1 Construction

The PTs of series MDT 420 x/460 x are industry standard.

The main advantages are:

- manufactured under ISO 9002
- thermal stability
- resistance to aggressive media
- insensitivity to electromagnetic radiation (EMC)
- liquid-filled transmission system (mercury)
- pressure measurements in plastic melt up to a temperature of 400°C (750°F)
- maximum pressure 2000 bar

## 4.2 Description of functions

Through a closed, liquid-filled pressure transmission system, the PT furnishes an electrical signal that is proportional to the pressure of the melt.

The pressure applied by the medium is forwarded to the measuring diaphragm via the separating diaphragm and the transmission medium (standard configuration: mercury) in the capillary. The deflection of the measuring diaphragm changes the resistance of the strain gauge bonded to the measuring diaphragm. The strain gauge is a Wheatstone bridge.

An electric signal proportional to the pressure is generated via the supply voltage.

### 4.3 PT series

The MDA/LDA/TDA series PTs are also available as PT series. The PT types correspond to the MDA models, and the TPT types correspond to the TDA models; the number codes are identical. The PT series differs from the MDA series in that all specifications are given in US American units of measure.

E.g.:                      1 bar = 14,5 PSI  
                                  (Psi value is rounded)  
                                  2,54 cm= 1" (inch)

All other specifications are the same as in the MDT series.

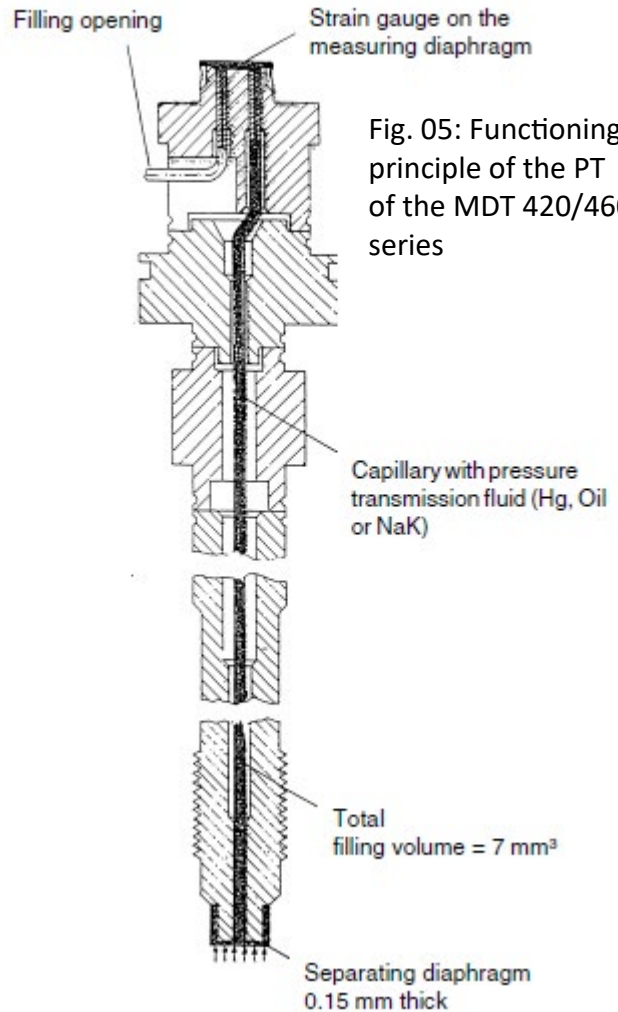


Fig. 05: Functioning principle of the PT of the MDT 420/460 series

## 5. Transport / delivery

- 5.1 Transport / packing / transport damage
- 5.2 Storage
- 5.3 Scope of delivery





## Toxic hazard!

The PT contains a very small amount of mercury (Hg) as its transmission medium. If the diaphragm is damaged, mercury may escape. Non-toxic NaK is being used in the LDA series. NaK is also available as an option for other pressure transducers. Never transport or store the PT without the protective shell bolted in place. Remove the shell shortly before installation.

**If mercury is inhaled or swallowed, seek medical attention immediately.**

Mercury is hazardous waste and must be disposed of in accordance with applicable laws. **DYNISCO** will accept defective PTs.

If mercury escapes, use airtight packaging!

Alternative, non-toxic transmission media (Oil or NaK) available on request.

ESD sensitive component. Electrostatic discharge may damage the PT. Take ESD precautions.

**ATTENTION**

## 5.1 Transport/packing/transport damage

- Do not let the PT be damaged by other items during transit.
- Use only the original packaging.
- Report transport damage to **DYNISCO** immediately in writing.

## 5.2 Storage

- Store the PT in original packaging only.
- Protect against dust and moisture.

## 5.3 Scope of delivery

- PT with diaphragm protection cap
- Cable socket
- Fastening clip (transmitter with flexible stem only)
- Calibration sheet
- Operating manual



## 6. Installation



- 6.1 Mounting hole
- 6.2 Checking the mounting hole
- 6.3 Mounting the Pressure Transmitter
- 6.4 Mounting PTs with flexible stem
- 6.5 Electrical connection
  - 6.5.1 EMC /  $\text{CE}$  compliant connection
- 6.6 Connection assignments
- 6.7 Wiring
- 6.8 Connection thermocouple /RTD element

### **ATTENTION**

Am biant temperature for the electronics housing max. +120°C. Higher temperatures can result in damage and malfunctions. Mount the PT only in locations where these temperatures are not exceeded.

## 6.1 Mounting hole

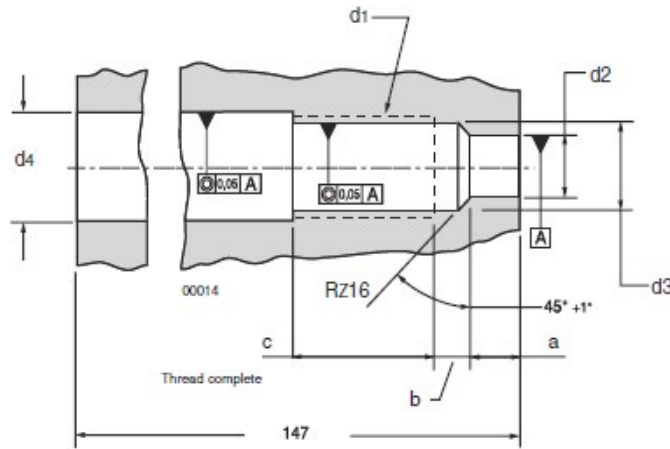
### **ATTENTION**

To produce the mounting hole, use only **DYNISCO** machining tool kit.

- Drill the mounting hole as shown in figure 06/07.

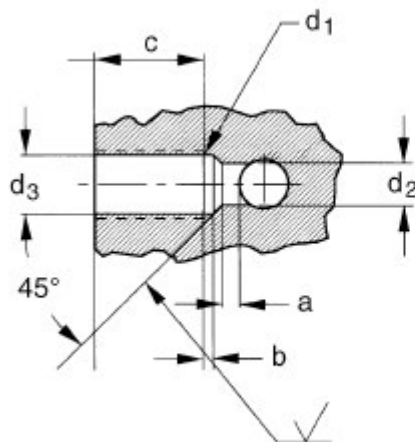


Fig. 06: Mounting hole for transmitter  
MDT 420, 460, 422, 462, 432, 463



$d_1$	$d_2$	$d_3$	$d_4$	a	b	c
1/2"-20UNF-2B	$7,92^{+0,05}$	$11,5^{+0,1}$	13	5,7	4	19
M18 x 1,5	$10,1^{+0,05}$	$16,3^{+0,1}$	20	6,15	4	25

Fig. 07: Mounting hole for transmitter MDT467 x



$d_1$	$d_2$	$d_3$
1/2"-20UNF-2B	$7,92^{+0,05}$	$11,5^{+0,2}$
a	b	c
3	1,5	17

When reworking the mounting hole, pay particular attention to the centricity of:

- the hole,
- the thread and
- the sealing surface.



Pressure sealing takes place on the 45° beveled sealing surface and on the front cylindrical section of the PT (see figures 06 and 07).

The sealing surface must be:

- correctly machined
- free from marks and rough edges
- free from solidified plastic residue.

## 6.2 Checking the mounting hole

- Paint the test bolt DYNISCO on the marked area (figure 08, item 1) with marking ink up to the thread.

Fig. 08: test bolt with marking ink



- Insert the test bolt in the mounting hole
- Twist it in by hand until the two sealing surfaces make contact.
- Remove and examine the test bolt.

The only acceptable abrasion of marking ink is at the sealing edge (45°), evenly (!) over the entire circumference.

If the ink has been rubbed off in other places too:

- rework the mounting hole.

## 6.3 Mounting the Pressure Transmitter



Mounting and electrical connection of the PT must be done by specialists with EMC training, following all applicable regulations, and in **pressureless, voltage-free** condition with the **machine switched off**.

**The machine must be secured against being switched back on!**

**Toxic hazard!**



(Only when using standard models with mercury)

The PT contains a small amount (7 mm<sup>3</sup>) of mercury (Hg) as its transmission medium. If the diaphragm is damaged, mercury may escape.

Never transport or store the PT without the protective shell bolted in place. Remove the shell shortly before installation.

**If mercury is inhaled or swallowed, seek medical attention immediately!**

Alternative, non-toxic transmission media (Oil or NaK) available on request.

**ATTENTION**

ESD sensitive component. Electrostatic discharge may damage the PT. Take ESD precautions.

**ATTENTION**

Before mounting the PT, check the mounting hole carefully. The PT must only be mounted in holes that satisfy the requirements stipulated in chapter 6.1. A hole that does not satisfy these requirements can damage the PT.

**ATTENTION**

Before mounting the PT, ensure that the mounting hole is free from plastic residue. Remove plastic residue with the **DYNISCO** cleaning tool kit. A test bolt is included with this cleaning set.

**ATTENTION**

To prevent the PT from sticking permanently in the mounting hole, coat the thread section of the transmitter with high temperature resistant grease or a suitable parting agent.

- Check the mounting hole with the test bolt, and clean with cleaning set if necessary.
- Coat the thread section of the transmitter with high temperature resistant grease or a suitable parting agent.

**ATTENTION**

Always use a spanner applied to the designated hexagon collar when screwing the PT in and out. Do not apply the tool to the housing or housing/sensor connection!



**ATTENTION**

Maximum mounting torque **50 Nm**. If the mounting torque is too high, the PT may be damaged or its zero point may shift.

- screw the PT into the mounting hole and tighten.

## 6.4 Mounting PTs with flexible stem

Mounting a PT with a flexible stem to the pressure sensor is done analogously to the procedure in 6.3.

**ATTENTION**

Avoid kinking or crushing the flexible stem.

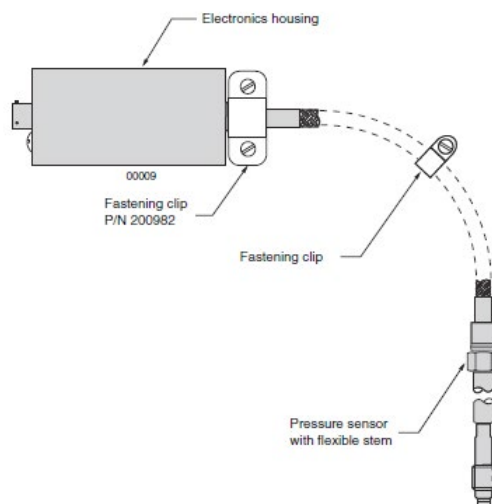
Minimum bending radius

- 25 mm for protected capillary
- 2 mm for unprotected capillary  
(MDT 435 / 467)

The connector must be easily accessible.

- Mount the electronics housing of the PT with the fastening clip **DYNISCO P/N 200982** (included). See mounting example in figure 09.
- Additionally secure the flexible stem between the electronics housing with a standard cable clip.

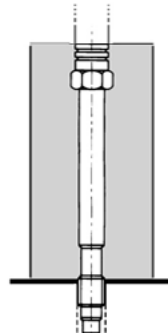
Fig. 09: Mounting example for Pressure Transmitter with flexible stem



### 6.4.1 Thermo Insulation

When installing the TDA please consider that the stem needs sufficient insulation. The insulation must cover the entire stem (see drawing). The thermo insulation is necessary for the correct temperature measurement.

Fig. 10:



### 6.5 Electrical connection



**ATTENTION**

**ATTENTION**

**ATTENTION**

**ATTENTION**

Mounting and electrical connection of the PT must be done by specialists with EMC training, following all applicable regulations, and in **pressureless, voltage-free** condition with the machine switched off.

**The machine must be secured against being switched back on!** ESD sensitive component. Electrostatic discharge may damage the PT. Take ESD precautions.

Avoid laying the power cable in the direct vicinity of cables carrying higher voltages or switching inductive or capacitive loads.

An EMC compliant power supply must be used. The electrical connection must comply with EMC requirements.

If the electrical connection is not made as described in chapter 6.5.1, or if cables / cable connectors / cable glands other than those stipulated by **DYNISCO** are used, **DYNISCO** cannot guarantee that EMC requirements will be satisfied.



## 6.5.1 EMC / €compliant connection

- Earth the machine section with the screw-in trunnion / mounting hole for the PT in accordance with regulations. The PT must be connected to earth via the screw-in trunnion / mounting hole.
- Connect the shield of the connecting cable on both sides, making sure it conducts with full and continuous contact.
- When introducing the connecting cable into an EMC compliant switch cabinet, for example, connect the shield correctly (cable gland, conducting, full contact, continuous) to the conductive housing or route it via built-in cable connector that is also connected to the conductive housing.
- Connect unused cable cores or free cable ends correctly to the cable shield on both sides.

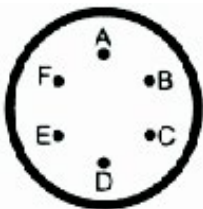
For order numbers of EMC compliant cable connectors required for connecting the PT, see chapter 9, Accessories.

## 6.6 Connection assignments

**Standard models MDT 4xx x-xxx-xx:**

Equipment connector: 6-pin male,  
Bendix PT02A-10-6P  
Cable socket: PT06A-10-6S(SR)

Fig. 11: 6-pin female connector



Top view solder side

PIN	Designation
A	signal (+)
B	signal (-)
C	supply voltage (+)
D	supply voltage (-)
E	calibration
F	calibration

The connector housing is connected conductively to the housing of the PT.



**Modelle PT 4xx (PT 420 x/422 x/435 x/TPT432 x):**

Equipment connector: 8-pin male,  
Bendix PC02E-12-8P  
Cable socket: PC06A-12-8S(SR)

Fig. 12: 8-pin female connector

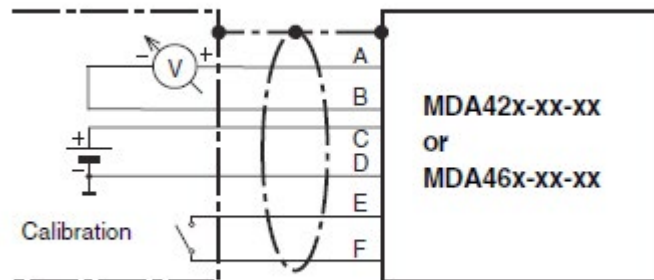
Top view solder side

The connector housing is connected conductively to the housing of the PT.

PIN	Designation
A	supply voltage (+)
B	signal (+)
C	supply voltage (-)
D	signal (-)
E	calibration
F	calibration
G	not used
H	not used

**6.7 Wiring**

Fig. 13: Wiring proposal 6-wire strain gauge



## 6.8 Connection thermocouple/RTD element (optional)

Fig. 14: Thermocouple connection

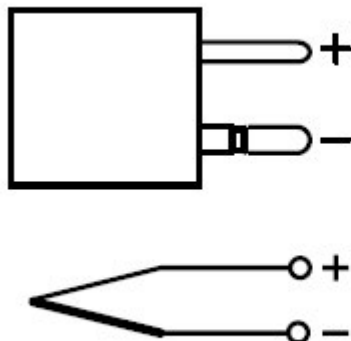
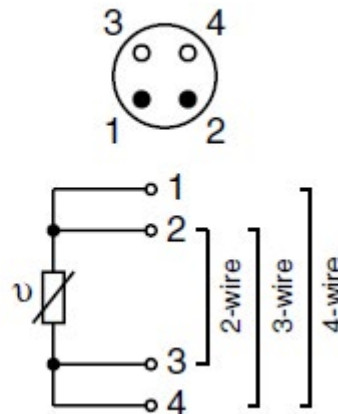


Fig. 15: PT100 connection



## 7. Commissioning

- 7.1 Supply voltage
- 7.2 Calibration
- 7.3 Zero adjustment
- 7.4 Operation



### ATTENTION

Before putting the PT into operation, make sure the PT is securely mounted and sealed.

### 7.1 Supply voltage

DYNISCO recommends operating the pressure transducer with a supply voltage of 10 VDC. Supply voltages from 6 to 12 VDC are permitted.

### ATTENTION

Using a supply voltage which is different from that stated in the technical specifications or has reversed polarity can damage the PT or cause it to malfunction.





## 7.2 Calibration

PTs of series MDT 420/460 have an internal calibration signal. Connecting terminals E and F switches the calibration signal to the signal output. It is 80% of the full scale pressure of the transmitter.

### **ATTENTION**

Calibrate in pressureless state and at room temperature. Other ambient temperatures will corrupt the signal.

### **ATTENTION**

Do not change the installed position of the PT after calibration. If the position is changed you must re-calibrate the PT.

- Connect a meter or suitable display unit to the signal output.
- Set the display unit or external amplifier to pressureless state (zero point).
- Connect terminals E and F. The calibration signal is connected to the output.
- Set the calibration value (80% of nominal pressure) on the display unit or external amplifier.
- Check the zero point setting on the display unit once again.

## 7.3 Zero adjustment

For PTs of series MDT 420 x/460 x, adjust zero at operating temperature!

- Wait until a steady operating temperature is reached at the pressure sensor.
- Set the zero point on the display unit or external amplifier.

## 7.4 Operation

### **ATTENTION**

Before starting the machine, wait until the melt medium at the diaphragm of the PT has reached its operating / processing temperature. If the machine is started before the medium reaches its operating temperature, the PT will be damaged. If it is hard to tell when the operating temperature has been reached, use a combined TDT PT with thermocouple.



**ATTENTION**

Operating temperature at the PT diaphragm max. 400°C (750°F). Higher temperatures will damage the PT.

**ATTENTION**

Ambient temperature for the electronics housing max. +120°C. Higher temperatures can result in damage or malfunctions.

Mount the PT only in locations where this temperature is not exceeded.

## 8.1 Maintenance



Mounting and electrical connection of the PT must be done by specialists with EMC training, following all applicable regulations, and in **pressureless, voltage-free** condition with the **machine switched off**.



**The machine must be secured against being switched back on!**  
**Burn hazard!**



The PT must be removed with the melt in molten condition. The PT can be very hot when removed.

**Wear protective gloves!**

ESD sensitive component. Electrostatic discharge may damage the PT. Take ESD precautions.

**ATTENTION**

Always remove the PT before cleaning the machine with abrasives or steel wire brushes or suchlike.

**ATTENTION**

Before removing the PT, the medium must be in molten condition. Removing the transmitter with the medium in solidified condition can damage the diaphragm of the PT.

**ATTENTION**

Do not clean the screw-in section of the PT with hard objects. This will damage the PT!

**ATTENTION**

**ATTENTION**

Always use a spanner applied to the designated hexagon collar when screwing the PT in and out. Do not apply the tool to the housing or housing/sensor connection!

- Remove the PT.
- Carefully clean the diaphragm of the transmitter with a soft cloth, while the medium is still malleable.

## 8.2 Thermocouple replacement TDT models

A defective thermocouple is easy to replace.

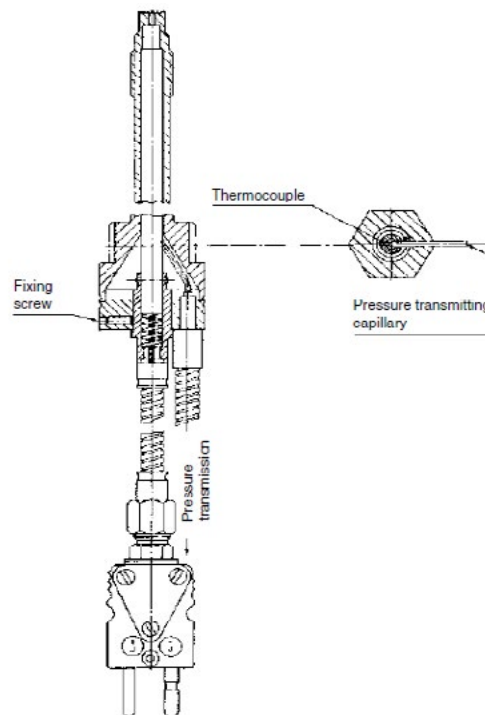
- Loosen the hexagon socket screw at the top end of the sensor stem.
- Remove the defective thermocouple from the probe stem.

### **ATTENTION**

When fitting the new thermocouple, the pressure transmitting capillary must be located in the slot of the thermocouple.

- Insert the new thermocouple all the way into the probe stem.
- Tighten the hexagon socket screw at the top of the sensor stem to secure the thermocouple.

Fig. 16: Thermocouple





## 8.3 Repair/disposal



### Toxic hazard!

The PT contains a small amount (7 mm<sup>3</sup>) of mercury (Hg) as its transmission medium. If the diaphragm is damaged, mercury may escape.

Never transport or store the PT without the protective shell bolted in place. Remove the shell shortly before installation.

**If mercury is inhaled or swallowed, seek medical attention immediately!**

Mercury is hazardous waste and must be disposed of in accordance with applicable laws. **DYNISCO** will accept defective PTs.

If mercury escapes, use airtight packaging!

Please send defective PTs to your **DYNISCO** representative.

For addresses, see the back cover of the operating manual.

## 9. Accessories

- Machining tool kit ½"-20UNF-2A  
P/N 8BRD0004
- Machining tool kit M18 x 1,5  
P/N 8BRD0005
- Cleaning tool kit ½"-20UNF-2A  
P/N 8BRD0009
- Cleaning tool kit M18 x 1,5  
P/N 8BRD0006
- Pressure sensor simulator
- Pressure sensor calibrating device





## Connectors, Cable glands, Cable



Designation	Order No.
Female connector DIN 7.pin	E311 0035
Female connector Bendix	E311 0029
Cable gland PG 7 CE	E447 0037
Connecting cable VT 460 - 6 meter	9VT0 0017
Connecting cable VT 460 - 10 meter	9VT0 0018

## 10. Troubleshooting



### 10.1 Troubleshooting

Fault	Possible cause	Resolution
No signal	Cable breakage or poor contact No supply voltage	Check cable and contact, or replace Check supply voltage
Strong zero shift when screwing in	Mounting hole incorrectly produced (alignment error) Mounting torque too high	Check hole with test bolt (chapter 6.2), rework with tool if necessary Adjust to max. 50 Nm mounting torque
No signal change despite pressure rise	Plug forming in front of diaphragm Diaphragm damaged	Check mounting hole; remove solidified plastic Send pressure transmitter to <b>DYNISCO</b> for repair



# 11. Declaration of conformity



**Konformitätserklärung**

**Declaration of conformity**  
**Declaración de conformidad**  
**Declaración de conformidad**  
**Declaração de conformidade**

**Dichiarazione di conformità**  
**Verklaring van overeenstemming**  
**Konformitetserklæring**  
 Atliútgáfu erkvæðisráðgjafarinn EÚ/EE

**Drucktransmitter / Druckaufnehmer**  
**Pressure Transmitter / Pressure Transducer**  
 Serie MDT, DMT, DT, MDA, DA, TDA, LCA, PT, Dynal

Няма съмнение за, във всеки случай, тип:  
 във всеки случай тип от продукта, тип:  
 Няма съмнение за в продукта от този продукт, тип:  
 Няма съмнение за в продукта от този продукт, тип:  
 Няма съмнение за в продукта от този продукт, тип:  
 Няма съмнение за в продукта от този продукт, тип:  
 Няма съмнение за, в този продукт и тип:  
 MA-тип измерители дълготрайни и с висока прецизност.

Използването е в съответствие с изискванията на всички свързани европейски директиви, които са в сила в момента на издаване на това заявление, и с всички свързани европейски директиви, които са в сила в момента на издаване на това заявление, и с всички свързани европейски директиви, които са в сила в момента на издаване на това заявление.

Използването е в съответствие с изискванията на всички свързани европейски директиви, които са в сила в момента на издаване на това заявление, и с всички свързани европейски директиви, които са в сила в момента на издаване на това заявление.

Използването е в съответствие с изискванията на всички свързани европейски директиви, които са в сила в момента на издаване на това заявление, и с всички свързани европейски директиви, които са в сила в момента на издаване на това заявление.

EN 60820-1 / EN 60820-2

DYNISCO EUROPE GMBH  
 WÄNNERSTADTSTRASSE 24  
 D-74078 Heilbronn  
 Tel: [0 71 31] 2 327 - 0  
 Fax: [0 71 31] 2 32 60

Heilbronn, den 1. März 2006

Hans-Joachim Müller



Dynisco Instruments  
38 Forge Parkway  
Franklin, MA 02038  
USA

Tel: +1 508 541 9400  
Fax: +1 508 541 9437  
Email: [Infolnst@dynisco.com](mailto:Infolnst@dynisco.com)

Dynisco Europe GmbH  
Wannenäckerstraße 24  
74078 Heilbronn  
Deutschland

Tel: +49 7131 2970  
Fax: +49 7131 23260  
Email: [DyniscoEurope@dynisco.com](mailto:DyniscoEurope@dynisco.com)

Dynisco Instruments S.a.r.l.  
466, rue du Marché Rollay  
94500 Champigny sur Marne  
France

Tel: +33 1 4881 8459  
Fax: +33 1 4881 8334  
Email: [DyniscoFrance@dynisco.com](mailto:DyniscoFrance@dynisco.com)

Dynisco.s.r.l.  
Via Adriatico, 2/2  
20162 Milano  
Italia

Tel: +39 02 661 01733  
Fax: +39 02 661 02908  
Email: [Dyniscoltaly@dynisco.com](mailto:Dyniscoltaly@dynisco.com)

Dynisco UK Ltd.  
Unit 2B Crowood House  
Gypsy Lane  
Swindon SN2 8YY  
Great Britain

Tel: +44 1527 577077  
Fax: +44 1527 577070  
Email: [DyniscoUK@dynisco.com](mailto:DyniscoUK@dynisco.com)

Azurr-Technology, s.r.o.  
cp. 579  
756 55 Dolni Becva  
Czech Republic  
Tel: +420 571 647 228  
Tel: +420 571 647 310

Email: [info@azurr-tech.cz](mailto:info@azurr-tech.cz)

[www.azurr-tech.cz](http://www.azurr-tech.cz)